



Cerraduras de embutir Mortise Locks



Las cerraduras de embutir de Yale le brindan a las puertas residenciales e institucionales alta seguridad y el mejor estilo.



Todas cuentan con placa en acero inoxidable que les permite su alta durabilidad mientras que los distintos tipos de cilindro y diseños de manijas hacen posible personalizar la cerradura según la puerta.

The Yale mortise lock program gives residential and commercial doors high security along with great style. The stainless steel plate in our lock case provides great durability in harsh environments. The different types of cylinder functions and lever trims allows the user to customize each lock case according to its application.

Glosario

Glossary

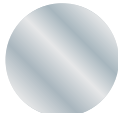
Características / Features:

 SS Acero Inoxidable Stainless Steel	 US15 Niquel Satinado Satin Nickel
 Backset 45 mm 45 mm backset	 Backset 50 mm 50 mm backset

Manijas Levers

Roma

- Manija para cerradura de embutir
- Cuerpo en acero inoxidable
- Garantía en partes mecánicas y materiales por 1 año

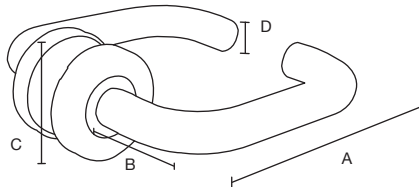

Roma

- Lever for mortise locks
- Stainless steel body
- Guaranteed for mechanical parts and materials for 1 year



MEDIDAS EN mm / MEASURES IN mm

A	B	C	D
137	61	54	19

SKU	DESCRIPCIÓN / DESCRIPTION
0010517	Lever Roma SS

Milán

- Manija para cerradura de embutir
- Cuerpo en acero inoxidable
- Garantía en partes mecánicas y materiales por 1 año

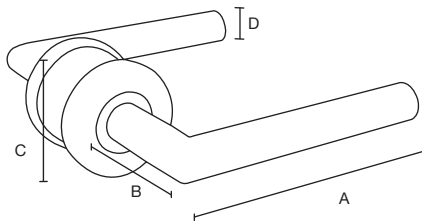

Milan

Lever for mortise locks

- Lever for mortise locks
- Stainless steel body
- Guaranteed for mechanical parts and materials for 1 year



MEDIDAS EN mm / MEASURES IN mm

A	B	C	D
133	59	54	19

SKU	DESCRIPCIÓN / DESCRIPTION
0010518	Lever Milán SS

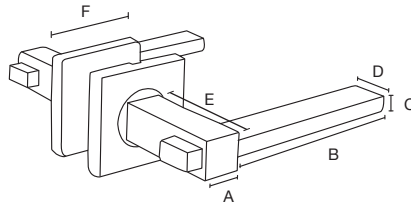

MEDIDAS EN mm / MEASURES IN mm

A	B	C	D	E	F
20	104	10	20	57	53

SKU	DESCRIPCIÓN / DESCRIPTION
0010519	Lever Turin SS

Turín

- Manija para cerradura de embutir
- Cuerpo en acero inoxidable
- Garantía en partes mecánicas y materiales por 1 año

Turin

- Lever for mortise locks
- Stainless steel body
- Guaranteed for mechanical parts and materials for 1 year



Cajas Cases

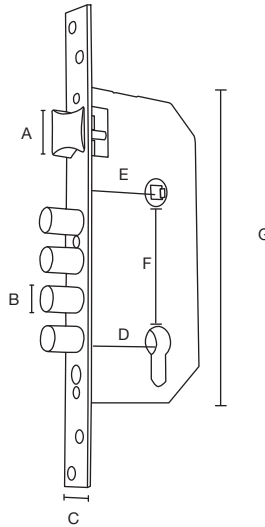

MEDIDAS EN mm / MEASURES IN mm

A	B	C	D	E	F	G
26	14	23	50	50	85	175

SKU	DESCRIPCIÓN / DESCRIPTION
0010520	Mortise 50 mm 4 bolt SS

Cerradura de embutir 50 mm

- 4 bulones de acero niquelado de diámetro de 14 mm y proyección de 20 mm
- Backset de 50 mm
- Ideal para puertas de entrada principal de metal o de madera
- Placa frontal en acero inoxidable
- Distancia entre ejes de 85 mm
- Función de entrada principal

50 mm Mortise lock

- 4 nickel plated bolts, 14 mm diameter, and 20 mm projection
- Backset : 50 mm
- Main entrance in metal or wood doors
- Stainless steel face plate
- Distance from lever to cylinder 85 mm
- Keyed entry function for main doors





Cerradura de embutir 50 mm

- Para puertas de entrada principal de metal o madera
- Cerradura de embutir con cerrojo y pestillo resbalón
- Cerrojo con proyección de 20 mm
- 50 mm de backset
- Ideal para puertas residenciales interiores o institucionales
- Placa frontal en acero inoxidable
- Distancia entre ejes de 85 mm

50 mm Mortise lock

- Main entrance in metal or wood doors
- Mortise lock with bolt and latch
- Bolt with 20 mm projection
- Backset 50 mm
- Recommended for residential and commercial interior doors
- Stainless steel face plate
- 85 mm distance from lever to cylinder

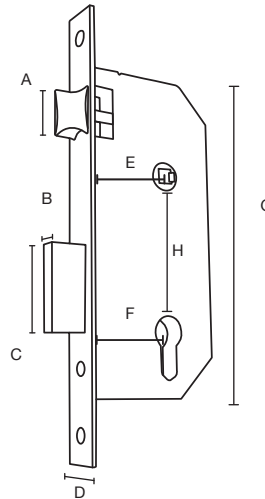

MEDIDAS EN mm / MEASURES IN mm							
A	B	C	D	E	F	G	H
26	11	45	23	50	50	173	85

SKU	DESCRIPCIÓN / DESCRIPTION
0010521	Mortise 50 mm SS

Cerradura de embutir 45 mm

- Para puertas de entrada principal de metal o madera
- Cerradura de embutir con cerrojo y pestillo resbalón
- Cerrojo con proyección de 20 mm
- 45 mm de backset
- Ideal para puertas residenciales interiores e institucionales
- Placa frontal en acero inoxidable
- Distancia entre ejes de 85 mm

45 mm Mortise lock

- Main entrance in metal or wood doors
- Mortise lock with latch bolt and latch
- Bolt with 20 mm projection
- Backset: 45 mm
- Recommended for residential and commercial interior doors
- Stainless steel face plate
- Distance from lever to cylinder 85 mm

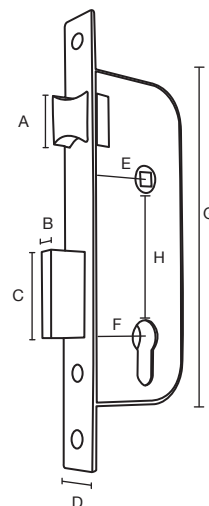

MEDIDAS EN mm / MEASURES IN mm							
A	B	C	D	E	F	G	H
27	10	47	23	45	45	175	85

SKU	DESCRIPCIÓN / DESCRIPTION
0010526	Mortise 45 mm SS

* Disponible en zona franca Cartagena.

* Available only in free trade zone Cartagena.



Cilindros Cylinders

Cilindro llave - llave

- Cilindro en latón de 62 mm
- 6 pines
- 3 llaves

Double cylinder

- 62 mm brass cylinder
- 6 pins
- 3 keys

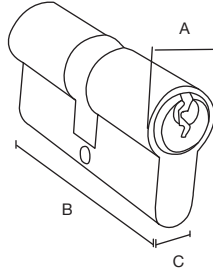

MEDIDAS EN mm / MEASURES IN mm

A	B	C
17	62	10

SKU	DESCRIPCIÓN / DESCRIPTION
0010522	Cyl Mor 62mm K-K US15
0010538	Cyl Mor 62mm K-K DK US15



* Llave plana disponible en bodega de Perú

* Dimple key available only in warehouse Perú.

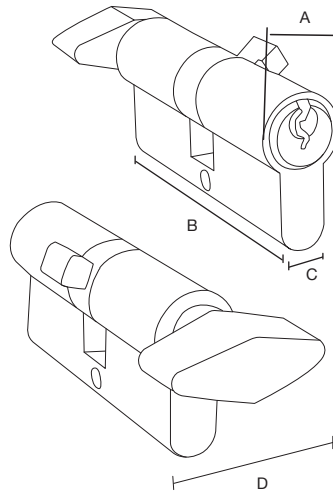

Cilindro llave - mariposa

- Cilindro en latón de 62 mm
- 6 pines
- 3 llaves

Cylinder with thumbturn

- 62 mm brass cylinder
- 6 pins
- 3 keys



MEDIDAS EN mm / MEASURES IN mm

A	B	C	D
17	62	10	31

SKU	DESCRIPCIÓN / DESCRIPTION
0010534	Cyl Mor 62mm K-T US15
0010537	Cyl Mor 62mm K-T DK US15